

側面
商標マーク  (沈み)
反対面は、サイズ表示(沈み)

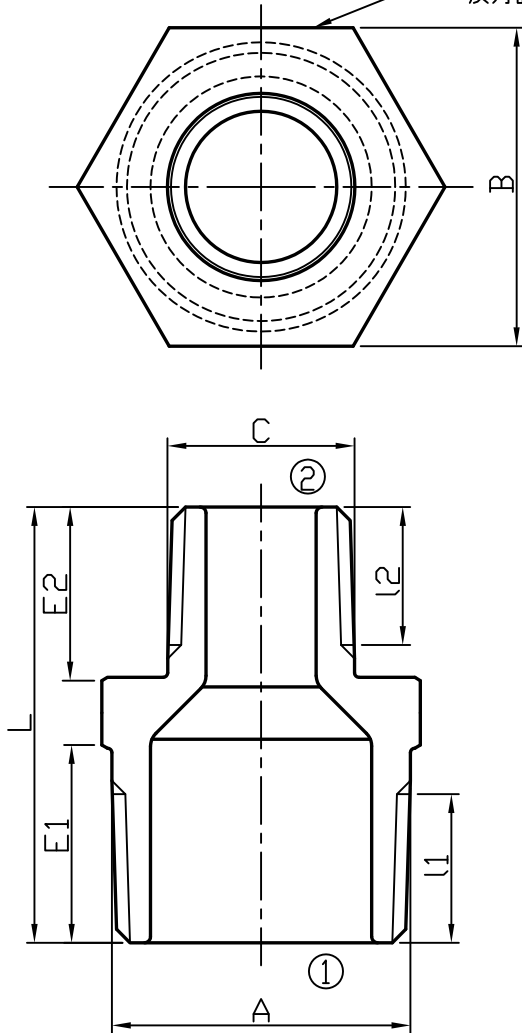

(単位:mm)

呼び		ねじ部長さ(参考)		外径(参考)		全長 L	E1(参考)	E2(参考)	二面幅B
①	②	l1	l2	A	C				
3/8	1/4	12	11	17	14	35	13	12	21
1/2	1/4	15	11	22	14	38	16	12	26
1/2	3/8	15	12	22	17	39	16	13	26
3/4	3/8	17	12	27	17	42	18	13	32
3/4	1/2	17	15	27	22	45	18	16	32
1	1/2	19	15	34	22	48	20	16	38
1	3/4	19	17	34	27	50	20	18	38
1 1/4	3/4	22	17	43	27	52	22	18	46
1 1/4	1	22	19	43	34	54	22	20	46
* 1 1/2	1/2	22	15	49	22	53	23	16	54
1 1/2	3/4	22	17	49	27	55	23	18	54
1 1/2	1	22	19	49	34	57	23	20	54
1 1/2	1 1/4	22	22	49	43	59	23	22	54
△ 2	3/4	26	17	61	27	59	25	18	63
2	1	26	19	61	34	61	25	20	63
2	1 1/4	26	22	61	43	63	25	22	63
2	1 1/2	26	22	61	49	64	25	23	63

*印は、JIS B2301にはないものですが、ご注文に応じ製作しております。

ねじは、JIS B0203管用テーパねじ(R)とする。

































・二面幅Bの寸法は推奨値である。



・2インチの二面幅Bは八角形

黒品表面：鑄放し

白品表面処理：溶融亜鉛めっき

記載内容については、予告なく変更することがあります。

また、許可なく無断で複製、転用を禁止します。                                

材質	FCMB275-5	尺度	Free	第三角法	顧客名
平成	18年	03月	01日		
承認	確認	作成	名	称	ねじ込み継手
					
記号	H26.10.6	追加(2×3/4)	奥地	担当	備考
日付		改訂	記事	株式会社	吉年
					PF-028-RNI-△

4
A